

استریویا

STERILIZATION & INFECTION CONTROL

**STERIWAY**



**STERIWAY**  
WWW.STERIWAY.CA  
CANADA - OFFICE

### low temperture plasma sterilizer 120 - 180 L



#### Specifications

Model Name	100/180
Usable Volume	180L
Dimension	860mm X 1040 X 1790
Chamber Dimension	450 X 520 X 800
Sterilizing Temp	45-55 c
Operating pressure	Vaccum 50pa
Sterilizing Agent	Cassette 58% H2O2
Main Controller	PLC
Display	10 inch -tft true color - touch screen
Process time	standard: 35min Short: 25min
Noise	low than 72dbi
input power	3 phase, 380+38v, 50+1Hz
power consumption	Max 4.5 KW
Weight	600Kg

### 30 - 60 L

#### Parameters:

Useable volume: 36L

Touch screen, USB port

Hydrogen peroxide cassette

Built-in thermal mini printer

Efficient cycle time: approx. 35mins

for standard cycle and 25mins for short cycle.

- Applicable for endoscope, Uteroscope, Gastroscope, mental&non mental, heat sensitive, humility sensitive surgical instruments.

Safe for surgical equipment such as cameras, rigid scopes, light cords, batteries, and power drill.

sterilization effectiveness:

500mm sterilization length for 1mm internal diameter stainless steel lumen (single channel).

2000mm sterilization length for 1mm internal diameter polytetrafluoroethylene lumen (single channel).



#### Specifications

Model Name	100/50B
Usable Volume	36L
Dimension	700mm X 960 X 680
Chamber Dimension	250 X 220 X 660
Sterilizing Temp	45-50 c
Operating pressure	Vaccum 50pa
Sterilizing Agent	Cassette 58% H2O2
Main Controller	PLC
Display	3.5 inch -tft true color - touch screen
Process time	standard: 35min Short: 25min
Noise	low than 72dbi
input power	220-230v, 50/60Hz
power consumption	Max 3 KW
Weight	135Kg

## Pulse Vacuum Steam Sterilizer

LK/MMQ-Z1.2 (Horizontal)



LK/MMQ-Z1.2 (Sliding door)



### Description

LK/MMQ-Z series Pulse Vacuum Steam Sterilizer meets with all national standards which ensures superior production efficiency. Guarantee the unsurpassed sterilization & drying effectiveness with the features of simple, safe, reliable and economical.

### Application range

Applicable to CSSD, TSSU, health care industry, Pharmaceutical factory, biological engineering, utensils, textile, sterile clothes, biological products, instruments and so on.

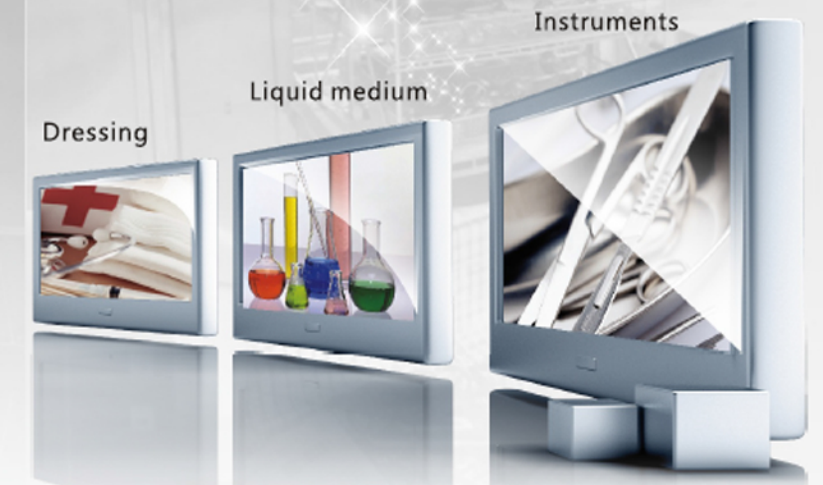

### Technical Data

Pressure	0.3MPa	Rated Working Pressure	0.21MPa
Temperature	140°C	Rated Working temperature	134°C
Steam source pressure	0.3-0.6 MPa	Water pressure	0.15-0.3 MPa
Compressed air pressure	0.5-0.7 Mpa	Control Power	3 phase 380V AC

Model	Parameter	Appearance Dims (LxWxHmm)	Chamber Dims (LxWxHmm)	Size (M <sup>3</sup> )	Steam Consume (Kg/cycle)	Water Consume (Kg/cycle)	Cycle Time(textile) (Time)	Control power (AC220V)	Dynamical power (3-AC380V/50Hz/KW)	N.W (Kg)
LK/MMQ-Z1.2 (Horizontal)		1900x1420x2010	1530x680x1160	1.2	35	360	42~45min	0.5KW	3.0KW	1900
LK/MMQ-Z1.2 (Sliding door)		2048x2225x2126	1530x680x1160	1.2	35	360	42~45min	0.5KW	3.0KW	1900
LK/MMQ-Z1.0 (Horizontal)		2092x1286x1940	1800x610x910	1.0	32	340	38~40min	0.5KW	3.0KW	1600
LK/MMQ-Z0.8 (Horizontal)		1742x1286x1940	1500x610x910	0.8	30	320	36~38min	0.5KW	2.2KW	1500
LK/MMQ-Z0.6 (Horizontal)		1472x1286x1940	1200x610x910	0.6	28	310	36~38min	0.5KW	2.2KW	1400
LK/MMQ-Z0.36 (Horizontal)		1306x1255x1780	980x600x600	0.36	25	280	30~33min	0.5KW	2.2KW	950

# MEDICAL WASTE AUTOCLAVE

1000 - 500 - 300 Lit

- Diaphragm Pressure Gauge
- German 316 Tri-clamp Valve
- Stainless Chamber
- Delta Control Panel
- German Pressure Transmitter
- High quality Air Filter
- 380V / 50Hz / 23kW
- Central Steam Connector



# Medical waste Shredder

## Applications

- Large-volume industrial waste - sheet metal and Plastic containers, cardboard boxes, foils, pallet scraps
- Hospital waste - syringes, cannulas, bandages
- Production waste, hospital waste
- File folders, IT lists, floppy disks, CD's
- Food, leftovers
- Raw material recycling - glass, plastics, paper



## Technical Data

Pressure	0.3MPa	Rated Working Pressure	0.21MPa
Temperature	140°C	Rated Working temperature	134°C
Steam source pressure	0.3-0.6 MPa	Water pressure	0.15-0.3 MPa
Compressed air pressure	0.5-0.7 Mpa	Control Power	3 phase 380V AC

# ENDOSCOPE WASHER-DISINFECTOR

## Model: MC3



Rapid  
Reliable  
Efficient

### EW-7 Endoscope Processing System

is an economical, easy-to-use high level disinfection system that can clean and high level disinfect, pre-cleaned, immersible, reusable and semi-critical devices such as flexible endoscopes and related accessories.

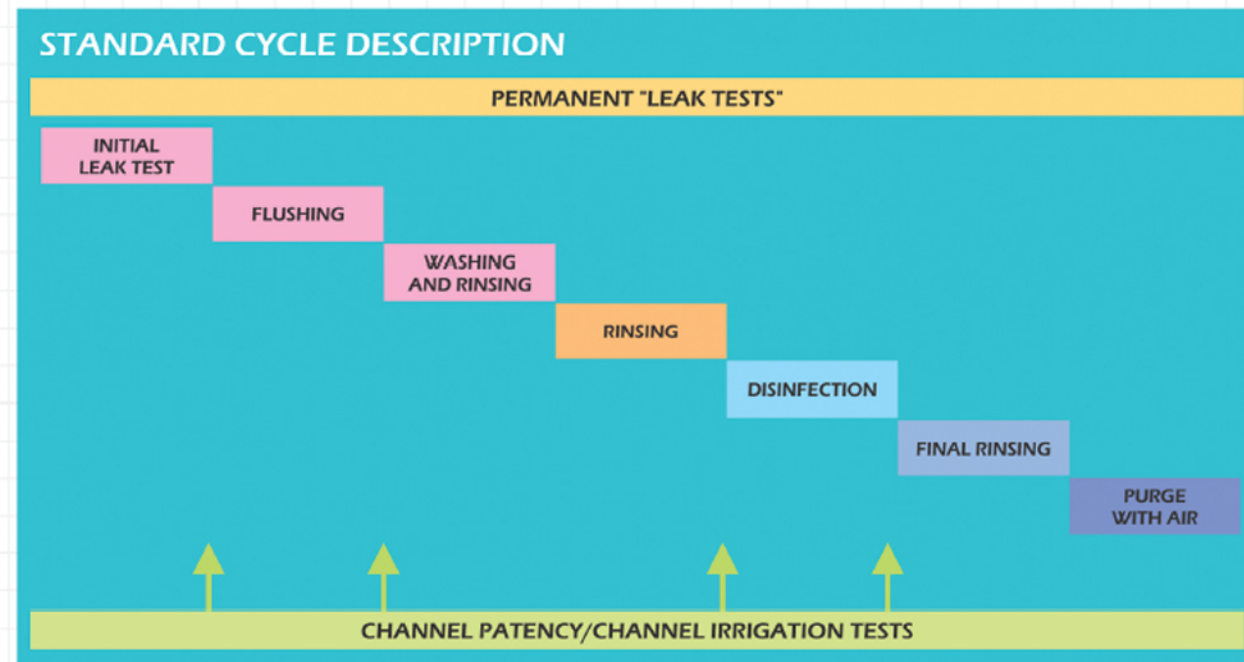

Design & manufacturing is according to **ISO 15883**.

### Connections

A unique Mercodor offer of compatible connections refers to more than ten years of collecting data on endoscopes. Mercodor connections are standard use in all our devices. They ensure an effective, safe and proven link between all Mercodor equipment and endoscopes.

### Data management solution

As an option the EW-7 can be equipped with Mercodor TRZ, the traceability platform designed to collect and record automatically electronic data.

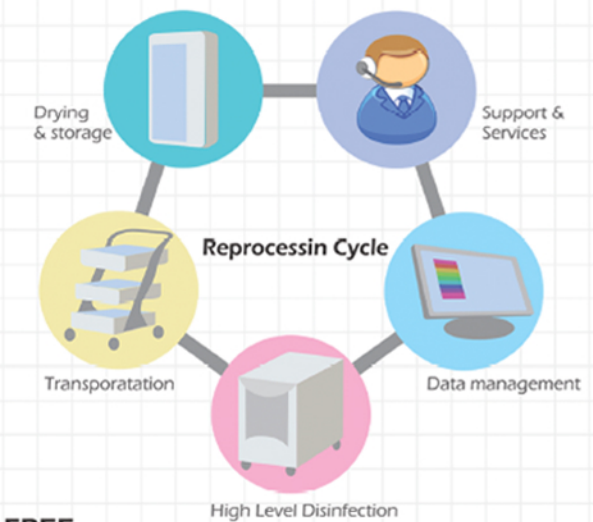

### A ROBUST TREATMENT FOR BACTERIA FREE RINSING WATER

**0.2 micron terminal water filter:** it ensures that bacteria free water is supplied to the EW-7.

**Water pre filtering:** whatever the water quality is, the EW-7 Prevents the risk of contamination by micro-organisms thanks to its set of 2 pre filters. Built-in and fully included in the process, the pre-filtering unit together with the terminal water filter is self-disinfected with the whole machine.



- OPTIMAL OPERATING TIME FOR CLEANING AND DISINFECTION
- A SECURE PROCESS FOR A RELIABLE RESULT
- Safe for your staff
- Safe for your patients

### Technical Specification

Capacity per cycle	1 endoscope, processing by immersion
Reprocessing cycle time	20 minutes (cycle 1)
Reprocessing temperature	PA: 35 to 40°C GTA: 35 to 45°C
Contact time/disinfection	10, 15, 30, 60 minutes
Traceability	Printer - TRS module (option)
Electrical connection	1x220-240V with 30 mA differential power breaker
Electrical frequency	50Hz
Maximum consumption	16A
Water input	Tap water
Water pressure	<4bars (58psi)
Water flow rate	4 L/min. minimum
Water hardness	10 to 30 TH (100 to 300mg/LCaCO3)
Water pH	6.5 to 9
Dimension (WxDxH)	65x60x105cm (dosed lid) 65x60x142cm (open lid)
Weight empty	85Kg
Weight full	110Kg

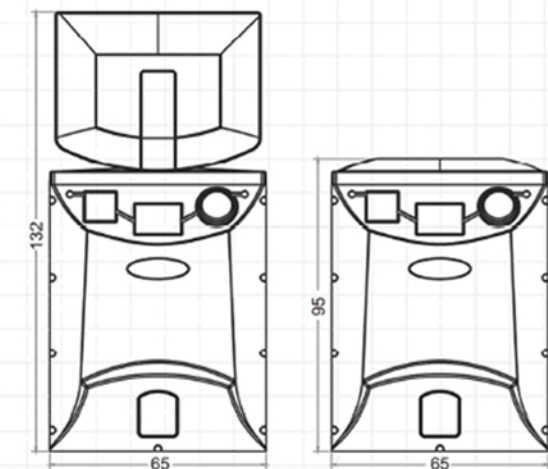

Design & manufacturing is according to **ISO 15883**.

# Macerator

## WASTE PAPER SHREDDER

Basin, Urine tube, Receivers &...  
Model : TT. DA



Paper containers, is shredded on the water by steel blades. Paper containers for liquids remaining pulp waste water (sewage) are discharged.

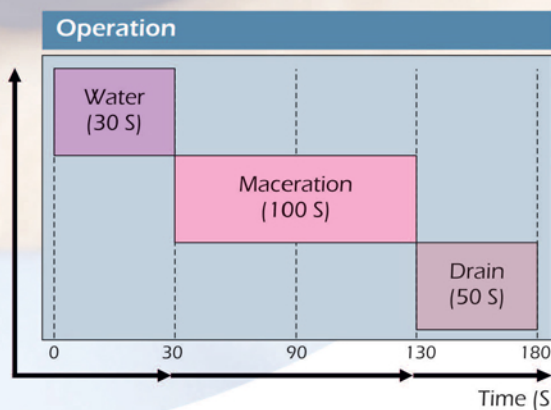

In this method, with disposable containers their contamination is destroyed



Rapid and accurate performance of the machine (the time performance is less than two minutes)

Easy to use for patient the hygiene principles

Reduce pollution and lack of transfer in different parts of the hospital

Elimination of pollution in dirty room

### Technical Specifications

Capacity	2 basin or 4 , Urine tube (Simultaneous)
Control board	PLC
Sink material	Stainless steel AISI 304 thickness 2 mm
Door and casing	ABS (ABS sheet)
Front panel	ABS (ABS sheet)
Cabinet	Stainless steel AISI 304
Shredded blades	Stainless steel AISI 304 thickness 3 mm
Door	Automatic
Water consumption	8 liter per cycle
Shredded power	1.1 kW
Output control sink	Electromechanical valve 2 inch
Electrical	220 V , 1 A , 50 Hz
Weight	85Kg
Dimensions (LxDxH)mm	550x700x1070

# WASHER & DISINFECTOR

Model: TT.IW 100/200



**Wash chamber** is constructed of argon-welded 20-gauge #304 L, stainless steel (No. 4 finish). Chamber inhibits Corrosion action of detergent, and is easy to clean, with no enameled surfaces to chip or crack should an object be accidentally dropped in chamber.

**Microprocessor control system** is equipped with a touch screen Customer interface. Control system monitors and controls all phase of each programmed cycle.

• Spray arm monitoring



• Automatic doors  
• Load panel control



• Unload panel control

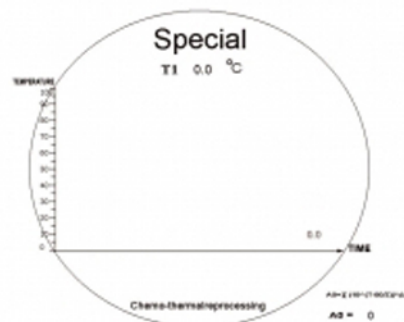

Graph cycle display

Design & manufacturing is according to iso 15883

# DENTAL INSTRUMENTS WASHER & DISINFECTOR

Bench type

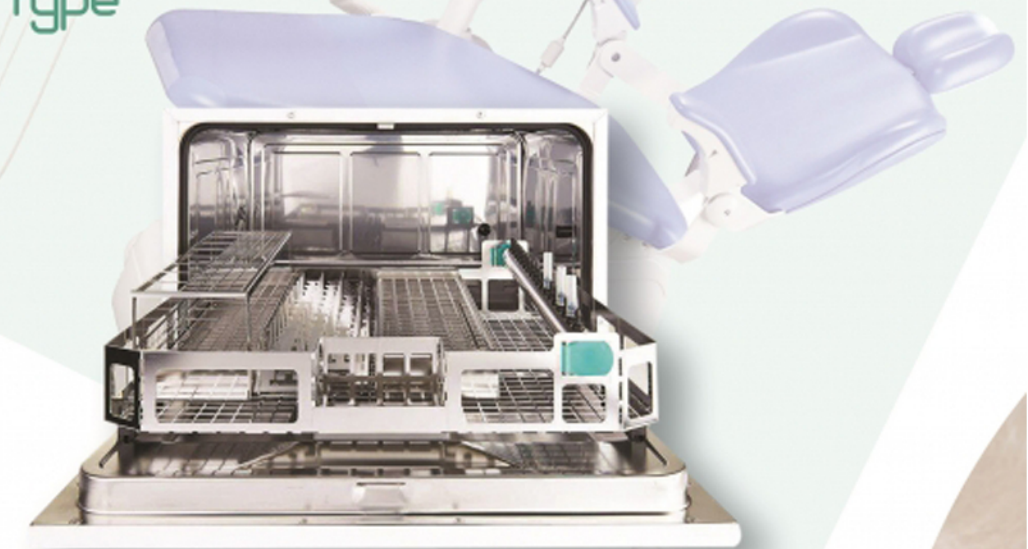

Model : T.T.IW - 74

## DENTAL INSTRUMENTS WASHER & DISINFECTOR (Bench type)

Model: T.T.IW - 74

The stainless-steel cabinet for the DENTAL WASHER & DISINFECTOR allows simple installation in an existing space in your sterilization line.

You can easily store your process chemicals or a further basic basket in the base cabinet.

It is also suitable for Gynecology, Dermatology, Podiatry, ENT, and Proctology.

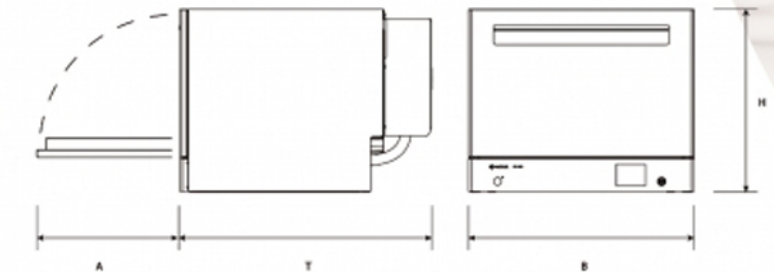

Design & manufacturing is according to iso 15883

**STERIWAY**  
Amalgam Separator



Equipped and Committed to assist the dental industry achieve environmentally sound and regulatory compliant practices.

provides the complete solution:

- ISO 11143 certified at greater than 99%
- Professionally engineered, robust, simple design.
- Easy to operate and maintenance free.
- Flexible design for hard-to-fit applications.
- Functional for wet or dry vacuum systems (install before pump on wet vacuum system, install before tank on dry vacuum system).

Simple container change process includes:

- NO TOOLS, NO MESS
- PACKAGING FOR DELIVERY TO CERTIFIED RECYCLER
- ONLINE CERTIFICATE ISSUED FOR PRACTICE

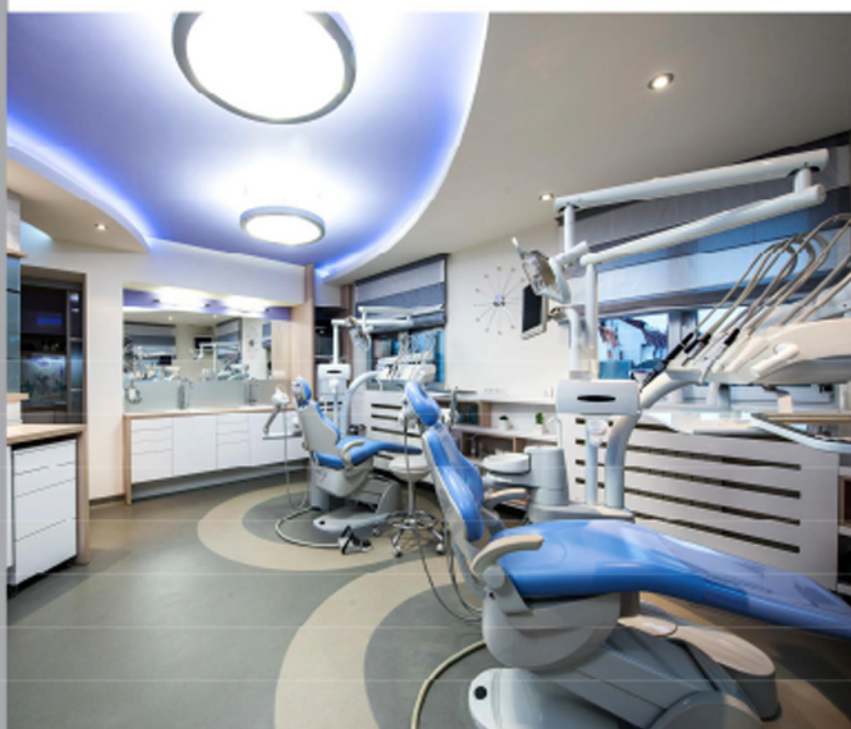
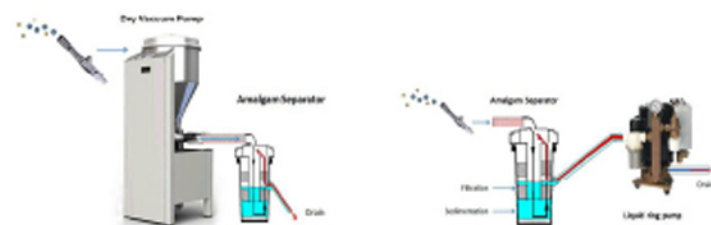

**AUTOCLAVE**  
**23 LIT**



Min. Temperature Display	0.1°C
Chamber Material	Stainless Steel
Cycle Time	30~55 min
Power Supply	220V AC 50-60Hz
External Dimension	471X696X395 mm
Chamber Dimension	φ245X450
Volume	25L

**Specifications**

- ◆ Automatic wash & maintenance
- ◆ CE marked and abide by EN13060 directive
- ◆ Microcomputer control with dynamic LCD display for running status, temperature, pressure and time
- ◆ Multiple pulse vacuum and positive pressure exhausting combined for guaranteed steam saturation level
- ◆ Imported vacuum pump can reach -0.85bar
- ◆ Motorola precision pressure sensor which can monitor 0.001 bar (1KPa)
- ◆ Sterilization programs for naked instruments, packed instruments, hemophilus and glassware
- ◆ PWM temperature control of chamber and jacket, saving power and water
- ◆ Self inspection function to monitor the whole sterilizing process and save relative record for validation analysis
- ◆ Smart pulse vacuum deep dry function, dressing material humidity less than 1%, naked instruments humidity less than 0.2%
- ◆ Two groups of independent temperature sensors for program control and system monitoring, eliminating sterilization failure due to temperature sensor failure or incorrect monitoring temperature value
- ◆ Built-in micro printer together with USB port to export cycle data
- ◆ Built-in memory for 50 cycles data
- ◆ Built-in smart help system for sterilization guidance
- ◆ Visual and vocal alarm when cycle ends or error occurs
- ◆ 1 button water refill with quick coupler
- ◆ Automatic cycle shut off



www.dta-med.com  
info@dta-med.com





◆ Specification Sheet

STERIWAY heat-seal sterilization reels flat - paper/film

ITEM NO	SIZES	PACK(REELS/CTN)
ST50200	50mm(2")*200m	12
ST55200	55mm(2.2")*200m	12
ST75200	75mm(3")*200m	8
ST100200	100mm(4")*200m	6
ST150200	150mm(6")*200m	4
ST200200	200mm(8")*200m	2
ST250200	250mm(10")*200m	2
ST300200	300mm(12")*200m	2
ST350200	350mm(14")*200m	2
ST400200	400mm(16")*200m	2
ST450200	450mm(18")*200m	2
ST500200	500mm(20")*200m	2
ST600200	600mm(24")*200m	2



◆ Specification Sheet

STERIWAY heat-seal sterilization reels gusseted - paper/film

ITEMS NO	SIZES	PACK(REEL/CTN)
STG75100	75mm(3")x100m	8
STG100100	100mm(4")x100m	6
STG150100	150mm(6")x100m	4
STG200100	200mm(8")x100m	2
STG250100	250mm(10")x100m	2
STG300100	300mm(12")x100m	2
STG350100	350mm(14")x100m	2
STG400100	400mm(16")x100m	2

◆ Specification Sheet

STERIWAY Heat-Sealing Sterilization Pouches Flat - Paper/Film

ITEM NO	SIZES	PACK(PCS/CTN)
STP75200	75mm*200mm	9600
STP75300	75mm*300mm	6400
STP100200	100mm*200mm	6400
STP100300	100mm*300mm	4800
STP150300	150mm*300mm	3200
STP200400	200mm*400mm	1600
STP250450	250mm*450mm	1600
STP300500	300mm*500mm	1200



Sterilization Reels and Pouches Flat – Tyvek/film



Tyvek is a non-woven polyethylene fabric manufactured by DuPont. It is known for its outstanding strength, durability and tear resistance. As well as industrial use for EO and Gamma sterilization. Tyvek is not suitable for steam sterilization, however perfectly compatible with the requirements of VH2O2 (plasma) sterilization. It is also the first option for gas sterilization, for Tyvek hardly absorbs any toxic gases and thus result in far below legal limit values of residual toxic gas levels.

STERIWAY Tyvek sterilization reels and pouches are made of uncoated Tyvek web and transparent multi-layer PET/PP copolymer film is decisively determined by the choice of materials. Two water based, non-toxic process indicators for hydrogen peroxide sterilization are imprinted on the Tyvek surface which prevents the instrument from colored and help to differentiate between processed and unprocessed packages. Formaldehyde(FORM) indicator available upon request as well.



◆ Brief advantages of STERIWAY Tyvek Sterilization Reels and Pouches:

- Excellent microbial barrier properties against germs, bacteria and moisture;
- Extremely high resistance to penetration and fibre-free peeling;
- Easy peel and aseptic presentation;
- Easy seal with old sealing machines;
- Clear and accurate color change.

◆ Standards:

STERIWAY tyvek sterilization reels and pouches comply to EN868, ISO11607 & ISO11140 standards.

◆ Sterilization Color Change

Turn to Wine Red from Purple under plasma sterilization:

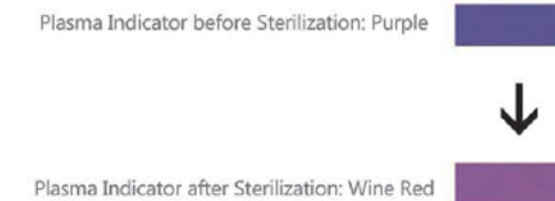

◆ Specification Sheet

STERIWAY sterilization reels flat - Tyvek/film

ITEM NO	SIZES	PACK(PCS/BOX)
STV50100	50mm(2")*100m	12
STV75100	75mm(3")*100m	8
STV100100	100mm(4")*100m	6
STV150100	150mm(6")*100m	4
STV200100	200mm(8")*100m	2
STV250100	250mm(10")*100m	2
STV300100	300mm(12")*100m	2
STV350100	350mm(14")*100m	2
STV400100	400mm(16")*100m	2
STV500100	500mm(20")*100m	2

### ◆Surgical Gown

**Description:**

STERIWAY surgical gowns are used widely in hospital and dental clinic. It can be used to protect the doctor's clothing from fluids and blood. It will offer highest level of all-over protection.

**Main Classification:**

Material: 30-60g SMS non-woven fabric or as your request.

Gown size: S,M,L,XL or as your request.

Type: Reinforce and Non-Reinforce



Knit Cuff



Waist Tie



Velcro And Tie



Holder Card



Ultra-Sonic Reinforce



Heat-Welded Ties





**FACTORY: IRAN - KORDAN**  
**DTA CO.LTD**  
**WWW.DTA-MED.COM**  
**INFO@DTA-MED.COM**  
**TEL: +98-21-88930929**



**INTERNATIONAL SALE OFFICE: CANADA - TORONTO**  
**STERIWAY CORPORATION**  
**WWW.STERIWAY.CA**  
**INFO@STERIWAY.CA**  
**TEL: +1-6473400101**